

PRODUCT CODE: AB23G
ADAPTABLE BOX - PLAIN

DESCRIPTION

300 x 300 x 75mm (12 x 12 x 3") Adaptable Box, Plain

FINISH

Pre Galvanised

MATERIAL

Galvanised Sheet Steel

PACKAGING

Supplied individually

ADDITIONAL NOTES

Comprises body, flanged cover and M5 x 10mm lid fixing screws
Plain sides (also available with pre-cut knockouts)
Compliant to LU Standard 1-085 (for use on surface & sub-surface locations)

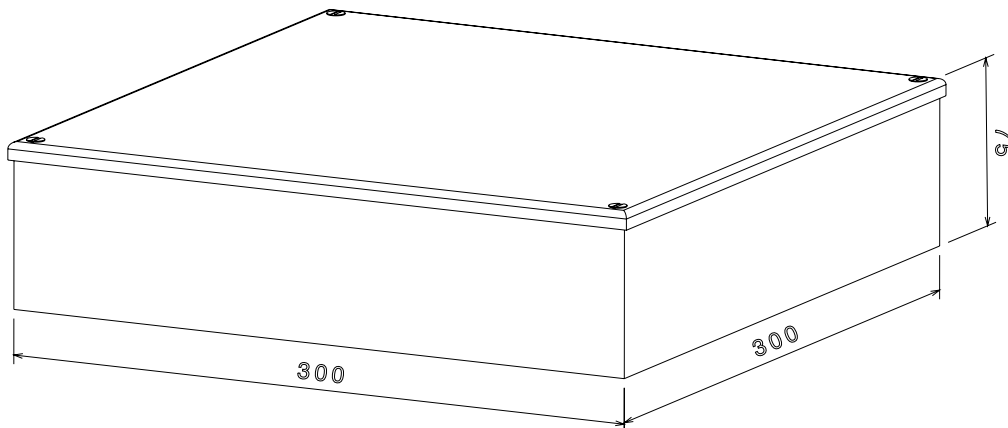
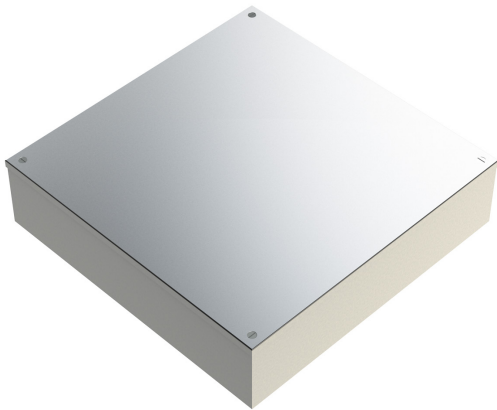

Isometric view

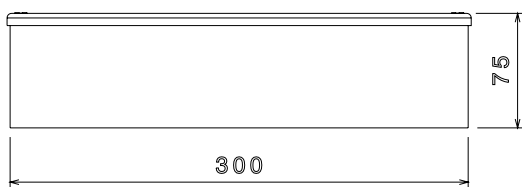

Front view

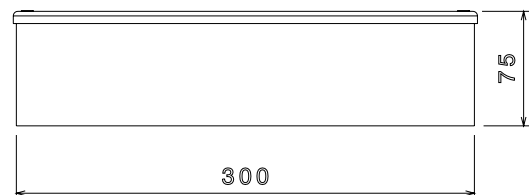

Side view